

客户代码 Customer code	
客户编号 Customer No	
客户确认 customer signature	

★充电插头:根据IEC62196标准
Charging plug: according to IEC62196 standard

版本 1.0	标记 --	ECN --	修订内容 初版图纸	签名 杨	日期 2024.04.24
-----------	----------	-----------	--------------	---------	------------------

插头触头布置图

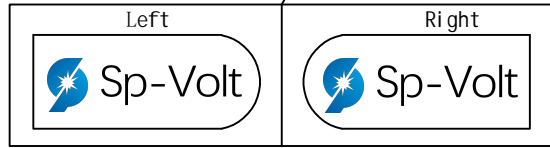
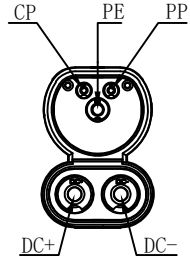

Plug frame LOGO

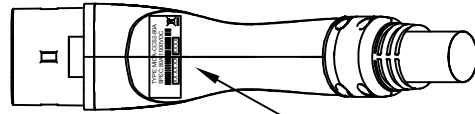

Prints logo

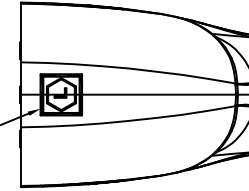

Laser laser content

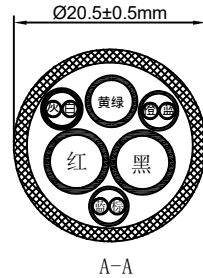
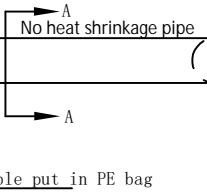
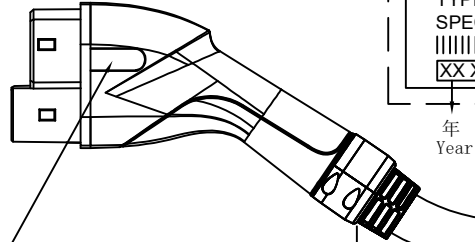
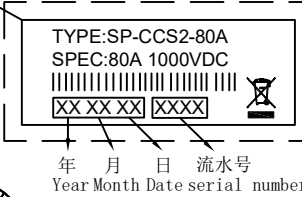

Cable length 4770 ± 50mm

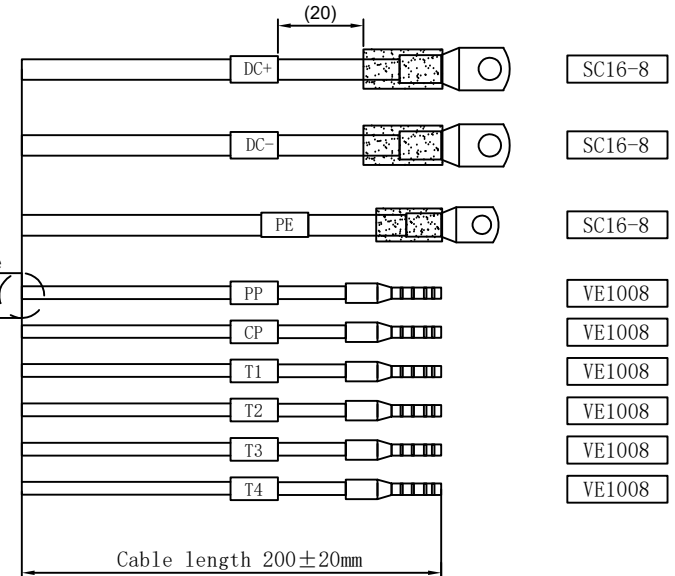

Product perimeter	
额定电压 Rated voltage	1000V DC
额定电流 Rated current	80A
环境温度 Ambient temperature	From -30°C to +50°C
绝缘电阻 Insulation resistance	At room temperature ≥ 500MΩ At hydrothermal environment: refer to IEC 62196
耐电压 Withstand voltage	DC+, DC- & PE 3500V AC, 60S, < 5mA
防护等级 IP Class	IP55 (PUT IN)
胶壳阻燃等级 Flame Rating	UL94V-0
插拔寿命 Mechanical life	≥ 10000 times (unload)
插拔力 Actuating Force	< 100N

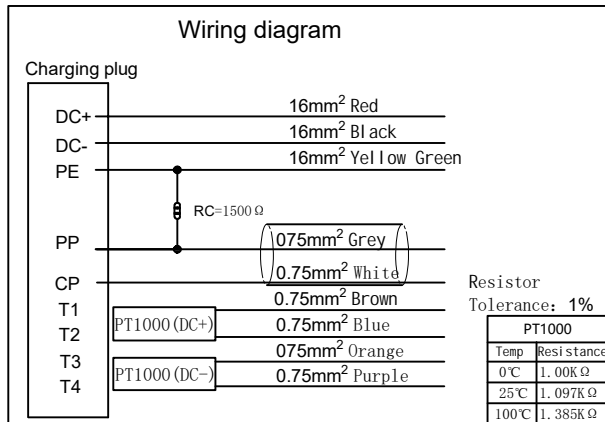

技术要求: (Technical Requirements)

- 1、端子拉脱力(Terminal pull out force): wire 0.75mm²>80N, 16mm²>1500N;
- 2、充电插头外壳材质 (Charging plug/housing material): PC/PA66;
- 3、导体材质 (Material of conductor): 铜合金, 表面镀银 (Copper alloy, silver plated);
- 4、电缆符合 (Cable standard); IEC62893 standard;
- 5、导通正确率为100%, 无错极现象 (The correct rate of conduction is 100%, no error pole phenomenon);
- 6、产品不能有刮花, 线缆破损, 脏污, 热缩套管脱落, 端子脱落等缺陷 (The product should be free from scratches, damaged cables, dirt, heat shrink tubing, and terminal);

	Cable	2*16mm ² +16mm ² +(2*0.75mm ²) (P2)+2*(2*0.75mm ²) TPU	5.00±0.03	M			
	Plug	DC CCS2 (2.0) 80A					
		SP VOLT EV CHARGING CABLE CO., LTD					
		外观颜色	产品名称	DC CCS2 (2.0) 80A			
		/	产品料号	20098-IDC2080U-WB05000			
		材质	产品型号	SP-CCS2-80A			
		/	视角投影	比例	图幅	单位	版本
		N/A		1:1	A4	mm	1.0